

## OPERATION

### Mild Steel

#### HySpeed 200 amps • O<sub>2</sub> Plasma / Air Shield

This gas combination gives superior cut speed, minimum dross, minimum surface nitriding and excellent weldability.

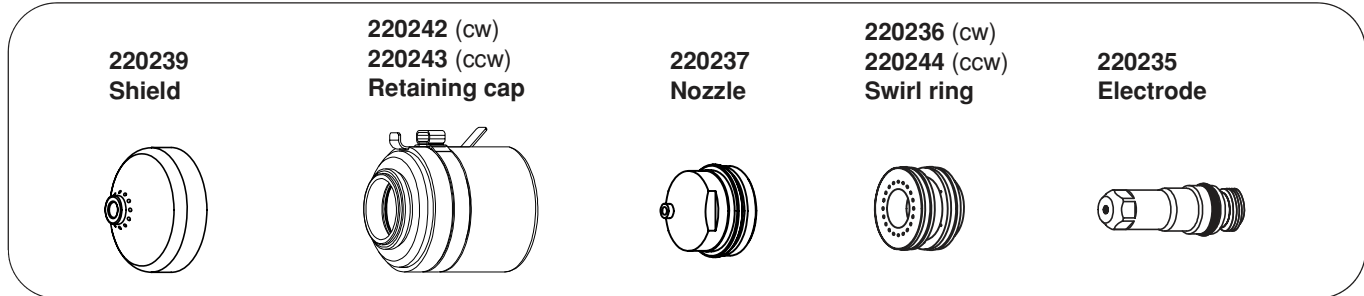

### Above Water

Material Thickness (inches)	Material Thickness (mm)	Plasma Gas Flow Rate %		Shield Gas (Air) Pressure (psi)	Torch-to-work Distance		Initial Torch Piercing Height		Arc Voltage Setting (volts)	Travel Speed		Approx. Motion Delay Time (sec)
		Preflow (O <sub>2</sub> % N <sub>2</sub> %)	Cutflow (O <sub>2</sub> % N <sub>2</sub> %)		(inches)	(mm)	(inches)	(mm)		(ipm)	(mm/min.)	
1/4	6	12 38	76 0	60	1/16	1.5	1/8	3	145	230	5800	0.3
5/16	8	(12 / 50	(90 / 0	(275	1/8	3	1/4	6	151	165	4200	0.3
3/8	10	SCFH)	SCFH)	SCFH)	5/32	4	5/16	8	155	140	3500	0.3
1/2	12				1/8	3	1/4	6	155	120	3000	0.3
5/8	15				1/8	3	1/4	6	155	100	2500	0.5
3/4	20				1/8	3	1/4	6	155	75	1900	0.6
7/8	22				1/8	3	1/4	6	159	60	1500	0.7
1	25				1/8	3	1/4	6	160	50	1300	0.7
1 1/4	32				1/8	3	5/16	8	168	30	760	2.6
1-1/2	38				1/8	3	5/16	8	175	20	500	4.0
1-3/4	44				1/8	3	N/A	N/A	180	15	380	N/A
2	50				1/8	3	N/A	N/A	188	10	250	N/A

### 3" Under Water

Material Thickness (inches)	Material Thickness (mm)	Plasma Gas Flow Rate %		Shield Gas (Air) Pressure (psi)	Torch-to-work Distance		Initial Torch Piercing Height		Arc Voltage Setting (volts)	Travel Speed		Approx. Motion Delay Time (sec)
		Preflow (O <sub>2</sub> % N <sub>2</sub> %)	Cutflow (O <sub>2</sub> % N <sub>2</sub> %)		(inches)	(mm)	(inches)	(mm)		(ipm)	(mm/min.)	
1/4	6	12 38	76 0	60	1/16	1.5	1/8	3	149	230	5800	0.3
5/16	8	(12 / 50	(90 / 0	(275	1/8	3	1/4	6	151	165	4200	0.3
3/8	10	SCFH)	SCFH)	SCFH)	5/32	4	5/16	8	159	140	3500	0.3
1/2	12				1/8	3	1/4	6	155	105	2700	0.3
5/8	15				1/8	3	1/4	6	161	90	2300	0.5
3/4	20				1/8	3	1/4	6	161	65	1600	0.6
7/8	22				1/8	3	1/4	6	161	55	1400	0.7
1	25				1/8	3	1/4	6	164	45	1100	0.7

Notes: **Set oxygen plasma gas inlet pressure to 120 psi (8.3 bar).**  
**Set nitrogen plasma gas inlet pressure to 120 psi (8.3 bar)**  
**Set shield gas inlet pressure to 90 psi (6.2 bar)**  
 Production cutting above 1" (25 mm) not recommended.  
 Drop cutting above 1-1/2" (38 mm) not recommended

### Mild Steel

200 amps • O<sub>2</sub> Plasma / Air Shield

This gas combination gives superior cut speed, minimum dross, minimum surface nitriding and excellent weldability.

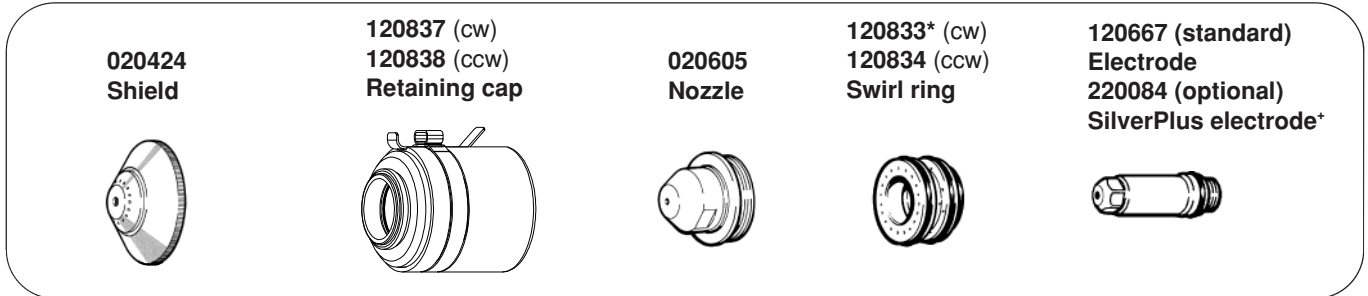

### Above Water

Material Thickness (inches) (mm)	Plasma Gas Flow Rate %		Shield Gas (Air) Pressure (psi)	Torch-to-work Distance (inches) (mm)		Initial Torch Piercing Height (inches) (mm)		Arc Voltage Setting (volts)	Travel Speed (ipm) (mm/min.)		Approx. Motion Delay Time (sec)
	Preflow (O <sub>2</sub> % N <sub>2</sub> %)	Cutflow (O <sub>2</sub> % N <sub>2</sub> %)		(inches) (mm)	(inches) (mm)	(inches) (mm)	(ipm) (mm/min.)				
1/4 6	<b>12 38</b>	<b>64 0</b>	<b>60</b>	1/8 3	3/8 10	1/4 6	120	160 4060	0.5		
.315 8	(14.9 / 50.4	(79.6 / 0	(270	1/8 3	3/8 10	1/4 6	125	120 3000	0.5		
3/8 10	SCFH)	SCFH)	SCFH)	1/8 3	3/8 10	1/4 6	125	100 2540	1.0		
1/2 12				.157 4	3/8 10	1/4 6	125	80 2030	2.0		
5/8 15				.157 4	3/8 10	1/4 6	130	70 1780	2.0		
3/4 20				3/16 5	3/8 10	1/4 6	135	55 1400	2.5		
7/8 22				1/4 6	1/2 12	1/4 6	135	45 1140	2.5		
1 25				1/4 6	1/2 12	1/4 6	140	35 890	2.5		
1 1/4 32				1/4 6			150	22 560			
1-1/2 38				1/4 6			155	15 380			
1-3/4 44				5/16 8			165	10 250			
2 50				5/16 8			170	7 180			

### 3" Under Water

Material Thickness (inches) (mm)	Plasma Gas Flow Rate %		Shield Gas (Air) Pressure (psi)	Torch-to-work Distance (inches) (mm)		Initial Torch Piercing Height (inches) (mm)		Arc Voltage Setting (volts)	Travel Speed (ipm) (mm/min.)		Approx. Motion Delay Time (sec)
	Preflow (O <sub>2</sub> % N <sub>2</sub> %)	Cutflow (O <sub>2</sub> % N <sub>2</sub> %)		(inches) (mm)	(inches) (mm)	(inches) (mm)	(ipm) (mm/min.)				
1/4 6	<b>12 38</b>	<b>64 0</b>	<b>70</b>	1/8 3	3/8 10	1/4 6	125	145 3700	0.5		
.315 8	(14.9 / 50.4	(79.6 / 0	(270	1/8 3	3/8 10	1/4 6	125	110 2800	0.5		
3/8 10	SCFH)	SCFH)	SCFH)	1/8 3	3/8 10	1/4 6	130	80 2000	1.0		
1/2 12				1/8 3	3/8 10	1/4 6	130	70 1800	2.0		
5/8 15				.157 4	3/8 10	1/4 6	135	60 1500	2.0		
3/4 20				3/16 5	3/8 10	1/4 6	140	48 1200	2.5		
7/8 22				1/4 6	1/2 12	1/4 6	140	38 950	3.0		
1 25				1/4 6	1/2 12	1/4 6	145	25 680	3.0		

Notes: Set oxygen plasma gas inlet pressure to 120 psi (8.3 bar).

Set nitrogen plasma gas inlet pressure to 120 psi (8.3 bar)

Set shield gas inlet pressure to 90 psi (6.2 bar)

Production cutting above 1" (25 mm) not recommended. Drop cutting above 1-1/2" (38 mm) not recommended

\* Use 020679 swirl ring in place of 120833 swirl ring to obtain smoother cut edges on material

1/4" to 3/8" thick, but expect a 30-40% decrease in electrode life

+ SilverPlus provides increased life to high duty cycle users in most applications. The hafnium wears to approximately twice the depth of an all copper electrode (120667). Arc voltage may need to be increased by 5-10 volts throughout the electrode life to maintain proper cut height parameters.

## OPERATION

### Mild Steel

200 amps • Air Plasma / Air Shield

This gas combination gives good cut speed, low dross levels and is very economical. Some surface nitriding can occur.

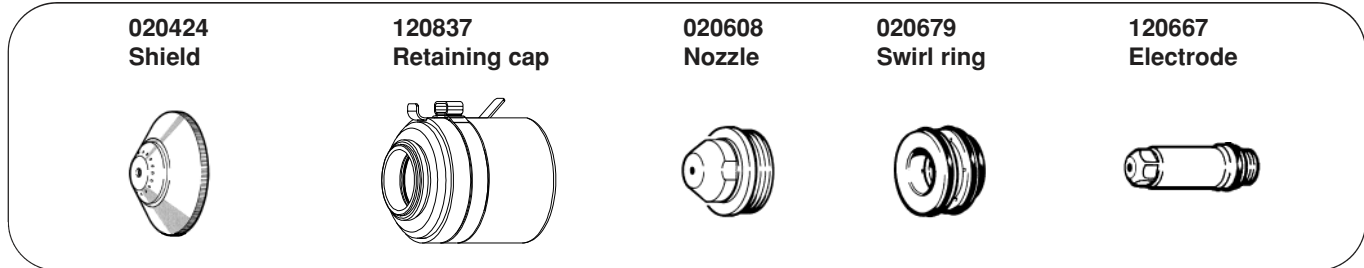

### Above Water

Material Thickness (inches) (mm)		Plasma Gas Flow Rate %		Shield Gas (Air) Pressure (psi)	Torch-to-work Distance (inches) (mm)		Initial Torch Piercing Height (inches) (mm)		Arc Voltage Setting (volts)	Travel Speed (ipm) (mm/min.)		Approx. Motion Delay Time (sec)
		Preflow (Air %)	Cutflow (Air %)		(inches)	(mm)	(inches)	(mm)		(ipm)	(mm/min.)	
3/16	5	<b>54</b>	<b>65</b>	<b>60</b>	1/8	3	1/4	6	130	200	5080	
1/4	6	(62.3	(75.0	(270	1/8	3	1/4	6	130	135	3400	0.5
.315	8	SCFH)	SCFH)	SCFH)	1/8	3	1/4	6	135	115	2900	0.5
3/8	10				1/8	3	1/4	6	135	100	2540	1.0
1/2	12				.157	4	.314	8	140	80	2030	2.0
5/8	15				.157	4	.314	8	145	60	1520	2.0
3/4	20				3/16	5	3/8	10	150	45	1140	2.5
7/8	22				1/4	6	1/2	12	155	30	760	2.5
1	25				1/4	6	1/2	12	160	25	635	2.5
1-1/4	32				1/4	6			165	15	380	
1-1/2	38				1/4	6			170	10	250	
1-3/4	44				5/16	8			180	7	180	
2	50				5/16	8			185	5	130	

### 3" Under Water

Material Thickness (inches) (mm)		Plasma Gas Flow Rate %		Shield Gas (Air) Pressure (psi)	Torch-to-work Distance (inches) (mm)		Initial Torch Piercing Height (inches) (mm)		Arc Voltage Setting (volts)	Travel Speed (ipm) (mm/min.)		Approx. Motion Delay Time (sec)
		Preflow (Air %)	Cutflow (Air %)		(inches)	(mm)	(inches)	(mm)		(ipm)	(mm/min.)	
1/4	6	<b>54</b>	<b>65</b>	<b>70</b>	1/8	3	1/4	6	130	130	3300	0.5
.315	8	(62.3	(75.0	(280	1/8	3	1/4	6	135	110	2700	0.5
3/8	10	SCFH)	SCFH)	SCFH)	1/8	3	1/4	6	135	95	2400	1.0
1/2	12				1/8	3	1/4	6	140	75	1900	2.0
5/8	15				.157	4	.314	8	145	50	1200	2.0
3/4	20				3/16	5	3/8	10	150	35	850	2.5
7/8	22				1/4	6	1/2	12	155	20	530	3.0
1	25				1/4	6	1/2	12	165	15	400	3.0

Notes: **Set plasma gas inlet pressure to 90 psi (6.2 bar)**  
**Set shield gas inlet pressure to 90 psi (6.2 bar)**  
 Production cutting above 1" (25 mm) not recommended  
 Drop cutting above 1-1/2" (38 mm) not recommended

### Mild Steel

200 amps • N<sub>2</sub> Plasma / CO<sub>2</sub> Shield

This gas combination may be used when cut edge quality and surface nitriding are less important. Electrode life is extended when using this combination.

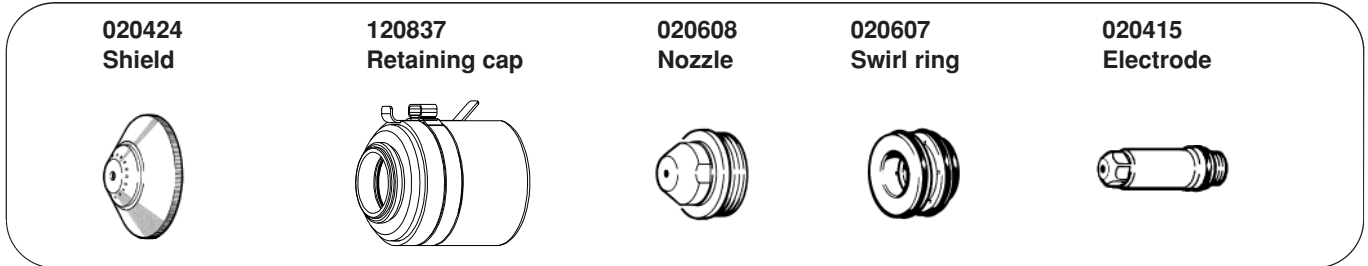

### Above Water Only

Material Thickness (inches) (mm)		Plasma Gas Flow Rate %		Shield Gas (CO <sub>2</sub> ) Pressure (psi)	Torch-to-work Distance (inches) (mm)		Initial Torch Piercing Height (inches) (mm)		Arc Voltage Setting (volts)	Travel Speed (ipm) (mm/min.)		Approx. Motion Delay Time (sec)
		Preflow (N <sub>2</sub> %)	Cutflow (N <sub>2</sub> %)		(inches)	(mm)	(inches)	(mm)		(ipm)	(mm/min.)	
3/16	5	<b>50</b>	<b>60</b>	<b>60/4</b>	1/8	3	1/4	6	120	130	3300	0.5
1/4	6	(62.3)	(75.0)	(270)	1/8	3	1/4	6	125	110	2800	1.0
3/8	10	(SCFH)	(SCFH)	(SCFH)	1/8	3	1/4	6	130	85	2160	1.5
1/2	12				1/8	3	1/4	6	130	55	1400	2.0
5/8	15				.157	4	.314	8	135	45	1140	2.0
3/4	20				3/16	5	3/8	10	145	25	635	2.5
7/8	22				1/4	6	1/2	12	150	20	510	3.0
1	25				1/4	6	1/2	12	160	15	380	3.0
1-1/4	32				1/4	6			165	10	250	
1-1/2	38				1/4	6			175	5	130	

Notes: **Set plasma gas inlet pressure to 120 psi (8.3 bar)**  
**Set shield gas inlet pressure to 90 psi (6.2 bar)**  
 Production cutting above 1" (25 mm) not recommended

## OPERATION

### Mild Steel

100\* amps • Air Plasma / Air Shield

This gas combination gives good cut speed, low dross levels and is very economical. Some surface nitriding can occur. While this process may be used on thicker materials, optimal recommended range is to 3/8" (10mm).

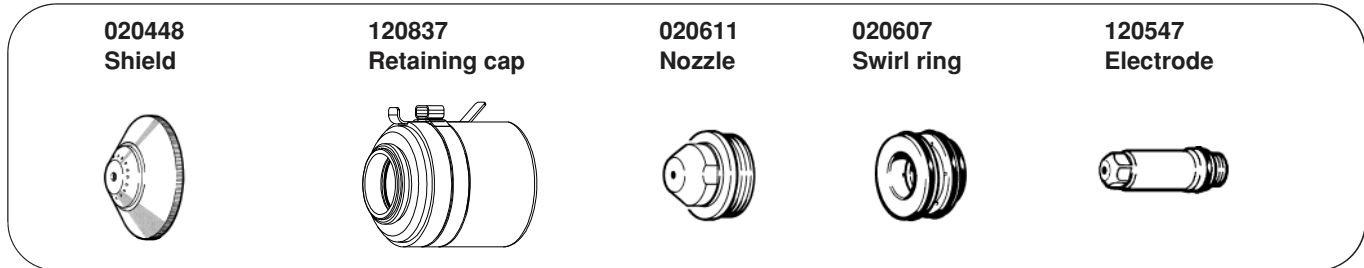

### Above Water

Material Thickness (inches)	Material Thickness (mm)	Plasma Gas Flow Rate %		Shield Gas (Air) Pressure (psi)	Torch-to-work Distance		Initial Torch Piercing Height		Arc Voltage Setting (volts)	Travel Speed		Approx. Motion Delay Time (sec)
		Preflow (Air %)	Cutflow (Air %)		(inches)	(mm)	(inches)	(mm)		(ipm)	(mm/min.)	
.075*	2	<b>48</b>	<b>39</b>	<b>60</b>	3/32	2.5	3/16	5	120	235	6050	
1/8	3	(55.3)	(44.9)	(270)	3/32	2.5	3/16	5	125	185	4700	0.5
3/16	5	SCFH)	SCFH)	SCFH)	1/8	3	1/4	6	125	175	4450	0.5
1/4	6				1/8	3	1/4	6	130	125	3175	0.5
3/8	10				1/8	3	1/4	6	135	50	1270	1.0
1/2	12				1/8	3			140	35	890	
5/8	15				.157	4			145	25	635	
3/4	20				3/16	5			150	20	510	

### 3" Under Water

Material Thickness (inches)	Material Thickness (mm)	Plasma Gas Flow Rate %		Shield Gas (Air) Pressure (psi)	Torch-to-work Distance		Initial Torch Piercing Height		Arc Voltage Setting (volts)	Travel Speed		Approx. Motion Delay Time (sec)
		Preflow (Air %)	Cutflow (Air %)		(inches)	(mm)	(inches)	(mm)		(ipm)	(mm/min.)	
1/8	3	<b>48</b>	<b>39</b>	<b>70</b>	5/64	2	5/32	4	130	120	3050	
3/16	5	(55.3)	(44.9)	(270)	1/8	3	1/4	6	135	90	2300	0.5
1/4	6	SCFH)	SCFH)	SCFH)	1/8	3	1/4	6	140	70	1730	0.5
3/8	10				1/8	3	1/4	6	145	42	1050	0.5
1/2	12				1/8				145	28	700	

\* Set arc current to **80 amps** when cutting .075" (2 mm) thick mild steel

Notes: **Set plasma gas inlet pressure to 90 psi (6.2 bar)**  
**Set shield gas inlet pressure to 90 psi (6.2 bar)**  
 Production cutting above 3/8" (10 mm) not recommended

### Mild Steel

100 amps • O<sub>2</sub> Plasma / Air Shield

This gas combination gives good cut speed, low dross and is very economical. Some surface nitriding can occur. While this process may be used on thicker materials, optimal recommended range is to 3/8" (10mm).

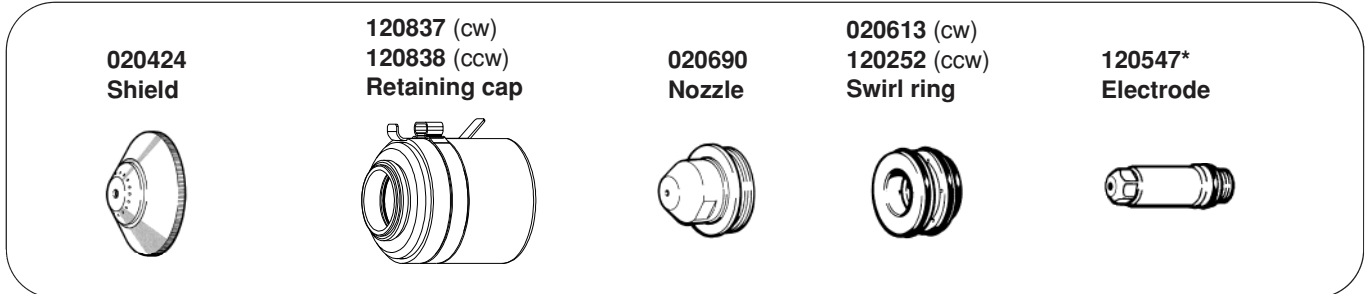

### Above Water

Material Thickness (inches) (mm)	Plasma Gas Flow Rate %		Shield Gas (Air) Pressure (psi)	Torch-to-work Distance (inches) (mm)		Initial Torch Piercing Height (inches) (mm)		Arc Voltage Setting (volts)	Travel Speed (ipm) (mm/min.)		Approx. Motion Delay Time (sec)
	Preflow (O <sub>2</sub> % N <sub>2</sub> %)	Cutflow (O <sub>2</sub> % N <sub>2</sub> %)		(inches) (mm)	(inches) (mm)	(ipm) (mm/min.)					
1/8 3	<b>7 28</b>	<b>36 0</b>	<b>60</b>	3/32 2.5	3/16 5	125	240 6100				
3/16 5	(9 / 37	(45 / 0	(270	1/8 3	1/4 6	125	180 4570				
1/4 6	SCFH)	SCFH)	SCFH)	1/8 3	1/4 6	125	120 3050	0.5			
3/8 10				1/8 3	1/4 6	130	90 2280	0.5			
1/2 12				1/8 3		130	60 1520				
5/8 15				.157 4		140	45 1140				
3/4 20				3/16 5		145	30 760				

### 3" Under Water

Material Thickness (inches) (mm)	Plasma Gas Flow Rate %		Shield Gas (Air) Pressure (psi)	Torch-to-work Distance (inches) (mm)		Initial Torch Piercing Height (inches) (mm)		Arc Voltage Setting (volts)	Travel Speed (ipm) (mm/min.)		Approx. Motion Delay Time (sec)
	Preflow (O <sub>2</sub> % N <sub>2</sub> %)	Cutflow (O <sub>2</sub> % N <sub>2</sub> %)		(inches) (mm)	(inches) (mm)	(ipm) (mm/min.)					
1/8 3	<b>7 28</b>	<b>36 0</b>	<b>60</b>	5/64 2	5/32 4	125	220 5580				
3/16 5	(9 / 37	(45 / 0	(270	1/8 3	1/4 6	125	160 4060	0.5			
1/4 6	SCFH)	SCFH)	SCFH)	1/8 3	1/4 6	125	110 2790	0.5			
3/8 10				1/8 3	1/4 6	130	85 2160	0.5			
1/2 12				1/8 3		135	60 1520				

- Notes: **Set oxygen plasma gas inlet pressure to 120 psi (8.3 bar)**  
**Set nitrogen plasma gas inlet pressure to 120 psi (8.3 bar)**  
**Set shield gas inlet pressure to 90 psi (6.2 bar)**

Production cutting above 3/8" (10 mm) not recommended

\* To maximize consumable life, modify the part lead-in and lead-out to reduce ramp-down errors.  
 For strip cutting or other applications where proper ramp-down is difficult to achieve, use electrode P/N 120667 in place of electrode P/N120547.

## OPERATION

### Mild Steel

50 amps • O<sub>2</sub> Plasma / O<sub>2</sub> Shield

**120185**  
Retaining cap

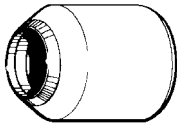

**120186**  
Shield

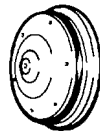

**120182**  
Nozzle



**120179**  
Swirl ring



**120178**  
Electrode



### Above Water Only

Material Thickness (inches) (mm)	Plasma Gas Flow Rate %		Shield Gas (O <sub>2</sub> ) Pressure (psi)	Torch-to-work Distance (inches) (mm)		Initial Torch Piercing Height (inches) (mm)		Arc Voltage Setting (volts)	Travel Speed (ipm) (mm/min.)		Approx. Motion Delay Time (sec)
	Preflow (O <sub>2</sub> % N <sub>2</sub> %)	Cutflow (O <sub>2</sub> % N <sub>2</sub> %)									
.048 (18 GA.)	<b>3 27</b>	<b>30 0</b>	<b>18</b>	.060	1.50	.120	3.0	108	160	4060	0
.074 (14 GA.)	4 / 36	37 / 0	35	.060	1.50	.120	3.0	108	120	3050	0.3
.100 (12 GA.)	SCFH	SCFH	SCFH	.070	1.75	.140	3.5	113	100	2540	0.3
.125 (10 GA.)				.080	2.00	.160	4.0	118	60	1520	0.5

Notes: **Set oxygen plasma gas inlet pressure to 120 psi (8.3 bar)**  
**Set nitrogen plasma gas inlet pressure to 120 psi (8.3 bar)**  
**Set shield gas inlet pressure to 120 psi (8.3 bar)**

The oxygen shield gas must be supplied from a regulator separate from the oxygen plasma gas regulator.

If using the Digital Remote (DR) or Programmable Remote (PR), set current to 60 amps.

If using a torch height control system capable of achieving the arc voltage setting on this chart, set accordingly.

If using a less sensitive torch height control system, round off the arc voltage numbers to the nearest achievable setting.

Torch-to-work Distance tolerances are ± .010 inch (± .25 mm). When using a THC the tolerances are ± 1 volt.

Stay within travel speed ranges to produce dross-free cuts.

Due to the low gas flow rates associated with the 50 amp process, initial cut quality may be degraded while nitrogen is being purged from the gas line when changing from preflow to cut flow (up to 2 seconds). To compensate, either increase machine motion delay or increase the lead-in distance at the start of the cut.

Note that some height control systems may need to be locked out to prevent the torch from diving into the plate if the machine motion delay option is used.

## Stainless Steel

200 amps • Air Plasma / Air Shield

This gas combination gives good cut speed, low dross and is very economical. Some surface nitriding and surface oxidation of alloying elements can occur.

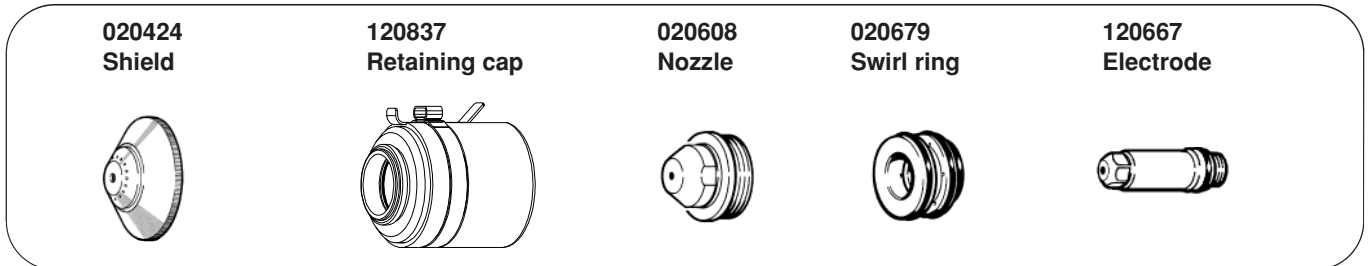

### Above Water

Material Thickness (inches) (mm)	Plasma Gas Flow Rate %		Shield Gas (Air) Pressure (psi)	Torch-to-work Distance (inches) (mm)		Initial Torch Piercing Height (inches) (mm)		Arc Voltage Setting (volts)	Travel Speed (ipm) (mm/min.)		Approx. Motion Delay Time (sec)
	Preflow (Air %)	Cutflow (Air %)		(inches)	(mm)	(inches)	(mm)		(ipm)	(mm/min.)	
3/16 5	<b>54</b>	<b>65</b>	<b>60</b>	1/8	3	1/4	5	125	220	5600	
1/4 6	(62.3	(75.0	(270	1/8	3	1/4	6	130	195	5000	0.5
3/8 10	SCFH)	SCFH)	SCFH)	1/8	3	1/4	6	130	145	3700	1.0
1/2 12				1/8	3	1/4	6	135	105	2700	2.0
5/8 15				.157	4	.314	8	140	75	1900	2.0
3/4 20				3/16	5	3/8	10	140	55	1400	2.5
7/8 22				1/4	6	1/2	12	145	40	1000	3.0
1 25				1/4	6			150	30	760	
1-1/4 32				1/4	6			160	15	380	
1-1/2 38				1/4	6			170	10	250	

### 3" Under Water

Material Thickness (inches) (mm)	Plasma Gas Flow Rate %		Shield Gas (Air) Pressure (psi)	Torch-to-work Distance (inches) (mm)		Initial Torch Piercing Height (inches) (mm)		Arc Voltage Setting (volts)	Travel Speed (ipm) (mm/min.)		Approx. Motion Delay Time (sec)
	Preflow (Air %)	Cutflow (Air %)		(inches)	(mm)	(inches)	(mm)		(ipm)	(mm/min.)	
3/16 5	<b>54</b>	<b>65</b>	<b>70</b>	1/8	3	1/4	6	125	210	5320	
1/4 6	(62.3	(75.0	(280	1/8	3	1/4	6	130	180	4500	0.5
3/8 10	SCFH)	SCFH)	SCFH)	1/8	3	1/4	6	135	125	3150	1.0
1/2 12				1/8	3	1/4	6	140	90	2300	2.0
5/8 15				.157	4	.314	8	145	60	1520	2.0
3/4 20				3/16	5	3/8	10	145	45	1150	2.5
7/8 22				1/4	6	1/2	12	150	30	750	3.0
1 25				1/4	6			155	22	570	

Notes: **Set air plasma gas inlet pressure to 90 psi (6.2 bar)**  
**Set air shield gas inlet pressure to 90 psi (6.2 bar)**  
 Production cutting above 7/8" (22 mm) not recommended



## OPERATION

### Stainless Steel

200 amps • N<sub>2</sub> Plasma / Air Shield

This gas combination is used when cut edge quality, surface nitriding and surface oxidation of alloying elements are less important. Electrode life is extended when this combination is used.

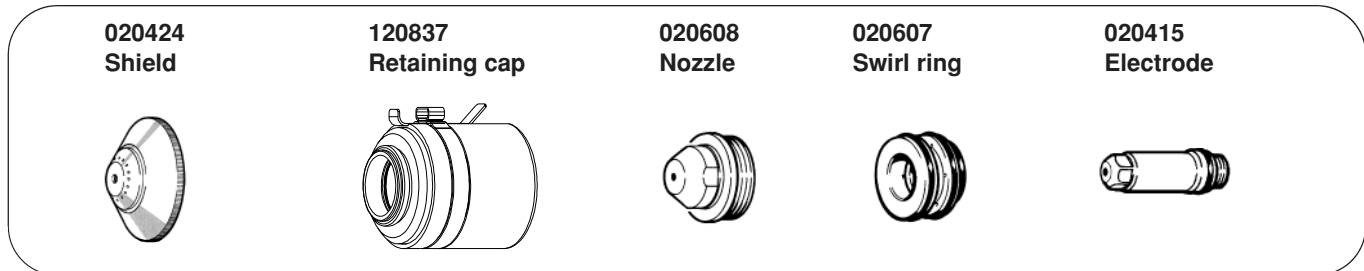

### Above Water

Material Thickness (inches) (mm)		Plasma Gas Flow Rate %		Shield Gas (Air) Pressure (psi)	Torch-to-work Distance (inches) (mm)		Initial Torch Piercing Height (inches) (mm)		Arc Voltage Setting (volts)	Travel Speed (ipm) (mm/min.)		Approx. Motion Delay Time (sec)
		Preflow (N <sub>2</sub> %)	Cutflow (N <sub>2</sub> %)									
3/16	5	<b>50</b>	<b>60</b>	<b>60</b>	1/8	3	1/4	5	125	135	3430	
1/4	6	(66.4	(79.6	(270	1/8	3	1/4	6	130	120	3050	0.5
3/8	10	SCFH)	SCFH)	SCFH)	1/8	3	1/4	6	130	100	2540	1.0
1/2	12				1/8	3	1/4	6	135	75	1900	2.0
5/8	15				.157	4	.314	8	140	60	1520	2.0
3/4	20				3/16	5	3/8	10	140	45	1140	2.5
7/8	22				1/4	6	1/2	12	145	35	890	2.5
1	25				1/4	6			150	20	510	
1-1/4	32				1/4	6			160	15	380	
1-1/2	38				1/4	6			160	10	250	

### 3" Under Water

Material Thickness (inches) (mm)		Plasma Gas Flow Rate %		Shield Gas (Air) Pressure (psi)	Torch-to-work Distance (inches) (mm)		Initial Torch Piercing Height (inches) (mm)		Arc Voltage Setting (volts)	Travel Speed (ipm) (mm/min.)		Approx. Motion Delay Time (sec)
		Preflow (N <sub>2</sub> %)	Cutflow (N <sub>2</sub> %)									
3/16	5	<b>50</b>	<b>60</b>	<b>70</b>	1/8	3	1/4	6	125	130	3250	
1/4	6	(66.4	(79.6	(280	1/8	3	1/4	6	130	110	2750	0.5
3/8	10	SCFH)	SCFH)	SCFH)	1/8	3	1/4	6	135	85	2160	1.0
1/2	12				1/8	3	1/4	6	140	60	1520	2.0
5/8	15				.157	4	.314	8	145	45	1140	2.0
3/4	20				3/16	5	3/8	10	145	30	800	2.5

Notes: **Set nitrogen plasma gas inlet pressure to 120 psi (8.3 bar)**  
**Set air shield gas inlet pressure to 90 psi (6.2 bar)**  
 Production cutting above 7/8" (22 mm) not recommended

## Stainless Steel

200 amps • N<sub>2</sub> Plasma / CO<sub>2</sub> Shield

This gas combination is used when surface nitriding and surface oxidation of alloying elements is less important. Electrode life is extended when using this gas combination.

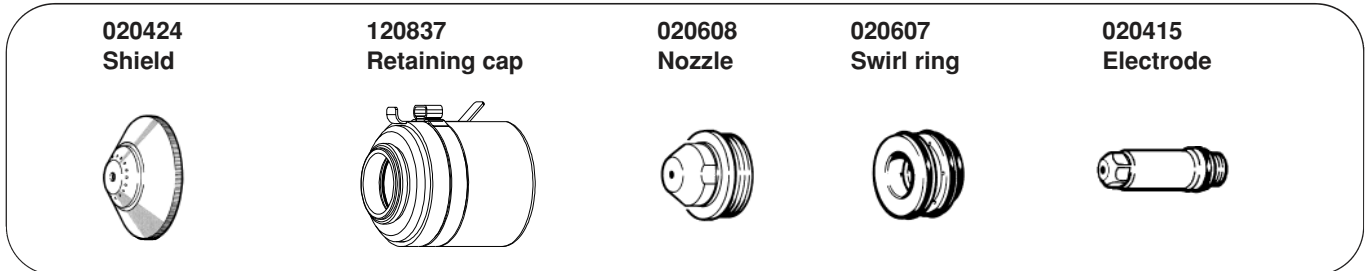

### Above Water

Material Thickness (inches) (mm)		Plasma Gas Flow Rate %		Shield Gas (CO <sub>2</sub> ) Pressure (psi)	Torch-to-work Distance (inches) (mm)		Initial Torch Piercing Height (inches) (mm)		Arc Voltage Setting (volts)	Travel Speed (ipm) (mm/min.)		Approx. Motion Delay Time (sec)
		Preflow (N <sub>2</sub> %)	Cutflow (N <sub>2</sub> %)		(inches)	(mm)	(inches)	(mm)		(ipm)	(mm/min.)	
3/16	5	<b>50</b>	<b>60</b>	<b>60</b>	1/8	3	1/4	6	125	190	4800	0.5
1/4	6	(66.4	(79.6	(210	1/8	3	1/4	6	130	170	4300	1.0
3/8	10	SCFH)	SCFH)	SCFH)	1/8	3	1/4	6	130	125	3200	1.5
1/2	12				1/8	3	1/4	6	135	95	2400	2.0
5/8	15				.157	4	.314	8	140	70	1800	2.0
3/4	20				3/16	5	3/8	10	140	50	1250	2.5
7/8	22				1/4	6	1/2	12	145	40	1000	3.0
1	25				1/4	6			150	30	760	
1-1/4	32				1/4	6			160	15	380	
1-1/2	38				1/4	6			170	10	250	

### 3" Under Water

Material Thickness (inches) (mm)		Plasma Gas Flow Rate %		Shield Gas (CO <sub>2</sub> ) Pressure (psi)	Torch-to-work Distance (inches) (mm)		Initial Torch Piercing Height (inches) (mm)		Arc Voltage Setting (volts)	Travel Speed (ipm) (mm/min.)		Approx. Motion Delay Time (sec)
		Preflow (N <sub>2</sub> %)	Cutflow (N <sub>2</sub> %)		(inches)	(mm)	(inches)	(mm)		(ipm)	(mm/min.)	
3/16	5	<b>50</b>	<b>60</b>	<b>60</b>	1/8	3	1/4	6	125	180	4550	0.5
1/4	6	(66.4	(79.6	(210	1/8	3	1/4	6	130	150	3850	1.0
3/8	10	SCFH)	SCFH)	SCFH)	1/8	3	1/4	6	135	110	2700	1.5
1/2	12				1/8	3	1/4	6	140	75	1920	2.0
5/8	15				.157	4	.314	8	145	50	1350	2.0
3/4	20				3/16	5	3/8	10	145	38	950	2.5
7/8	22				1/4	6	1/2	12	150	28	700	3.0

Notes: **Set nitrogen plasma gas inlet pressure to 120 psi (8.3 bar)**  
**Set carbon dioxide shield gas inlet pressure to 90 psi (6.2 bar)**  
 Production cutting above 7/8" (22 mm) not recommended

## OPERATION

### Stainless Steel

200 amps • H35 Plasma / N<sub>2</sub> Shield

Argon-Hydrogen Manifold (073109) Required\*

This gas combination (Hypertherm recommends a mixture of 35% hydrogen and 65% argon for the plasma gas) gives maximum thickness cutting capability, minimum dross levels, minimum amount of surface contamination, excellent weldability and excellent cut quality on thicknesses greater than 1/2". On thicknesses less than 1/2", excessive dross levels may be experienced. Electrode life is extended when this combination is used.

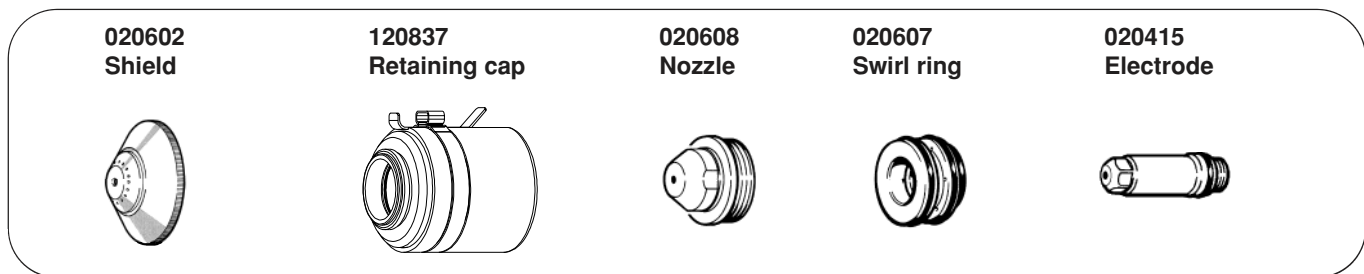
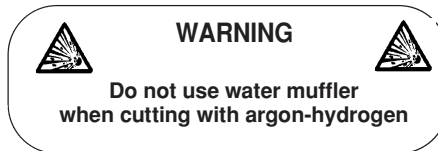

### Above Water Only

Material Thickness (inches) (mm)	Plasma Gas Flow Rate %		Shield Gas (N <sub>2</sub> ) Pressure (psi)	Torch-to-work Distance		Initial Torch Piercing Height		Arc Voltage Setting (volts)	Travel Speed		Approx. Motion Delay Time (sec)	
	Preflow (H35 %)	Cutflow (H35 %)		(inches)	(mm)	(inches)	(mm)		(ipm)	(mm/min.)		
1/4	6	<b>25</b>	<b>25</b>	<b>60</b>	3/16	5	3/8	10	135	62	1600	1.0
3/8	10	(89.9)	(89.9)	(275)	3/16	5	3/8	10	140	52	1300	1.0
1/2	12	SCFH)	SCFH)	SCFH)	3/16	5	3/8	10	140	42	1100	2.0
5/8	15				1/4	6	1/2	12	145	37	940	2.0
3/4	20				1/4	6	1/2	12	150	32	810	2.5
7/8	22				5/16	8	5/8	16	155	27	690	2.5
1	25				5/16	8			155	22	560	
1-1/4	32				5/16	8			165	16	400	
1-1/2	38				5/16	8			170	11	280	
1-3/4	44				5/16	8			180	8	200	
2	50				5/16	8			185	6	150	

\* See Section 7 for installation and operation with Argon-Hydrogen Manifold.

Notes: **Set argon-hydrogen plasma gas inlet pressure to 120 psi (8.3 bar)**  
**Set nitrogen shield gas inlet pressure to 90 psi (6.2 bar)**  
 Drop cutting above 1-1/2" (38 mm) not recommended.  
 Production cutting above 7/8" (22 mm) not recommended

## Stainless Steel

100 amps • Air Plasma / Air Shield

This gas combination gives good cut speed, low dross and is very economical. Some surface nitriding and surface oxidation of alloying elements can occur.

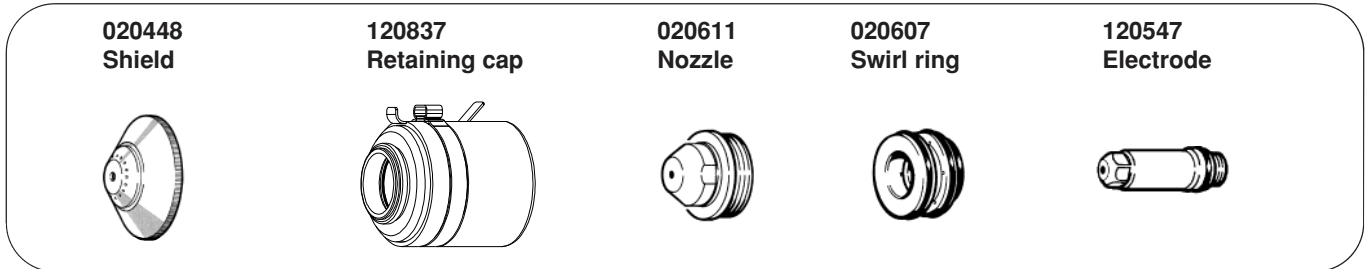

### Above Water

Material Thickness (inches) (mm)	Plasma Gas Flow Rate %		Shield Gas (Air) Pressure (psi)	Torch-to-work Distance (inches) (mm)		Initial Torch Piercing Height (inches) (mm)		Arc Voltage Setting (volts)	Travel Speed (ipm) (mm/min.)		Approx. Motion Delay Time (sec)
	Preflow (Air %)	Cutflow (Air %)		(inches)	(mm)	(inches)	(mm)		(ipm)	(mm/min.)	
1/8 3	<b>48</b>	<b>39</b>	<b>60</b>	3/32	2.5	3/16	5	125	140	3560	
3/16 5	(53.3	(44.9	(270	1/8	3	1/4	6	130	110	2800	0.5
1/4 6	SCFH)	SCFH)	SCFH)	1/8	3	1/4	6	130	80	2030	0.5
3/8 10				1/8	3	1/4	6	135	55	1400	0.5
1/2 12				1/8	3			140	35	890	
5/8 15				.157	4			145	25	635	
3/4 20				3/16	5			150	20	510	

### 3" Under Water

Material Thickness (inches) (mm)	Plasma Gas Flow Rate %		Shield Gas (Air) Pressure (psi)	Torch-to-work Distance (inches) (mm)		Initial Torch Piercing Height (inches) (mm)		Arc Voltage Setting (volts)	Travel Speed (ipm) (mm/min.)		Approx. Motion Delay Time (sec)
	Preflow (Air %)	Cutflow (Air %)		(inches)	(mm)	(inches)	(mm)		(ipm)	(mm/min.)	
1/8 3	<b>48</b>	<b>39</b>	<b>60</b>	5/64	2	5/32	4	125	135	3400	
3/16 5	(53.3	(44.9	(270	1/8	3	1/4	6	130	100	2520	0.5
1/4 6	SCFH)	SCFH)	SCFH)	1/8	3	1/4	6	135	65	1720	0.5
3/8 10				1/8	3	1/4	6	140	45	1120	0.5
1/2 12				1/8	3			145	25	670	

Notes: **Set air plasma gas inlet pressure to 90 psi (6.2 bar)**  
**Set air shield gas inlet pressure to 90 psi (6.2 bar)**  
 Production cutting above 3/8" (10 mm) not recommended

## OPERATION

### Stainless Steel

100 amps • H35 Plasma / N<sub>2</sub> Shield

Argon-Hydrogen Manifold (073109) Required\*

This gas combination (Hypertherm recommends a mixture of 35% hydrogen and 65% argon for the plasma gas) gives good cut speed, but may result in excessive dross. Some surface nitriding and surface oxidation of alloying elements can occur.

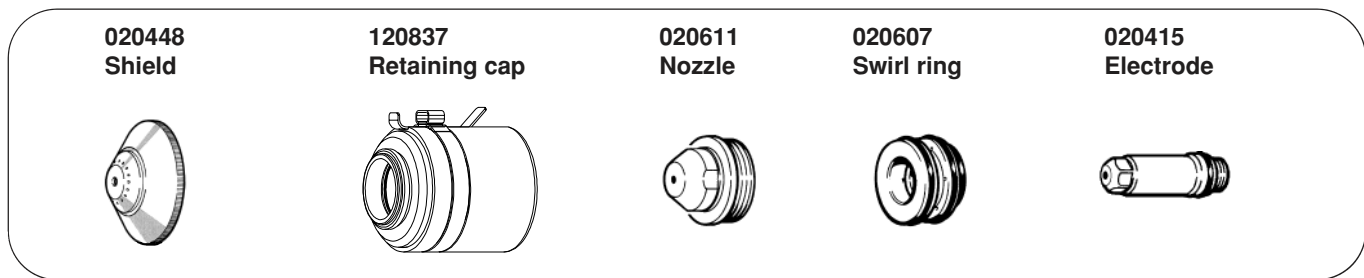
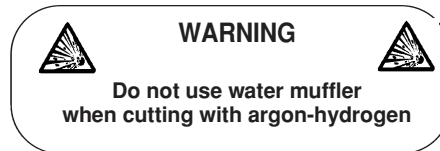

### Above Water Only

Material Thickness (inches)	Material Thickness (mm)	Plasma Gas Flow Rate %		Shield Gas (N <sub>2</sub> ) Pressure (psi)	Torch-to-work Distance		Initial Torch Piercing Height		Arc Voltage Setting (volts)	Travel Speed		Approx. Motion Delay Time (sec)
		Preflow (H35 %)	Cutflow (H35 %)		(inches)	(mm)	(inches)	(mm)		(ipm)	(mm/min.)	
1/8	3	<b>13</b>	<b>13</b>	<b>60</b>	3/32	2.5	3/16	5	130	50	1260	
3/16	5	(46.7	(46.7	(270	1/8	3	1/4	6	135	40	1060	0.5
1/4	6	SCFH)	SCFH)	SCFH)	3/16	5	3/8	10	140	35	890	0.5
3/8	10				3/16	5	3/8	10	140	30	750	0.5
1/2	12				3/16	5	3/8	10	145	25	630	1.0

\*See Section 7 for installation and operation with Argon-Hydrogen Manifold.

Notes: **Set argon-hydrogen plasma gas inlet pressure to 120 psi (8.3 bar)**  
**Set nitrogen shield gas inlet pressure to 90 psi (6.2 bar)**  
 Production cutting above 3/8" (10 mm) not recommended

## Stainless Steel

40 amps • Air Plasma / Air Shield

This gas combination gives good cut speed, low dross level and is very economical. Some surface nitriding and surface oxidation of alloying elements can occur.

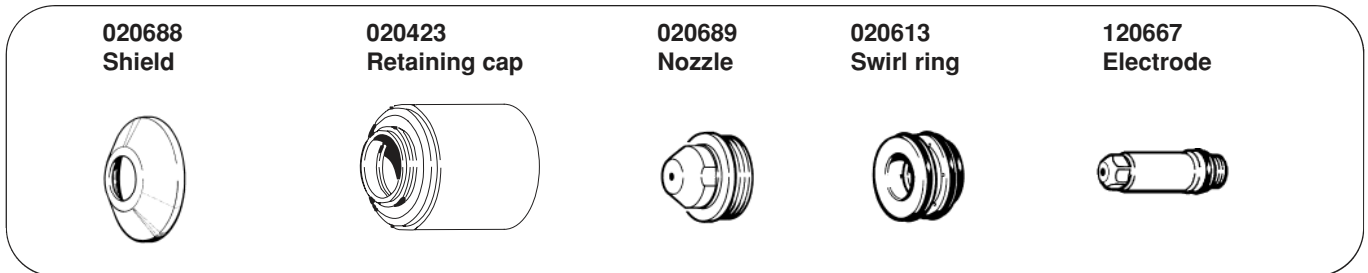

### Above Water Only

Material Thickness (inches) (mm)	Plasma Gas Flow Rate %		Shield Gas (Air) Pressure (psi)	Torch-to-work Distance (inches) (mm)		Initial Torch Piercing Height (inches) (mm)		Arc Voltage Setting (volts)	Travel Speed (ipm) (mm/min.)		Approx. Motion Delay Time (sec)
	Preflow (Air %)	Cutflow (Air %)									
.050 (18 GA.)	<b>40</b>	<b>20</b>	<b>60</b>	3/32	2.5	3/16	5	120	145	3700	
1/16	46.0	(23.1)	(275)	3/32	2.5	3/16	5	120	120	3050	
1/8	SCFH)	SCFH)	SCFH)	3/32	2.5	3/16	5	125	75	1900	0.5
1/4				1/8	3			135	24	610	
3/8				1/8	3			140	12	300	

Notes: **Set air plasma gas inlet pressure to 90 psi (6.2 bar)**  
**Set air shield gas inlet pressure to 90 psi (6.2 bar)**  
**Production cutting above 1/8" (3 mm) not recommended**

## OPERATION

### Aluminum

200 amps • Air Plasma / Air Shield

This gas combination gives good cut speed, low dross levels and is very economical.

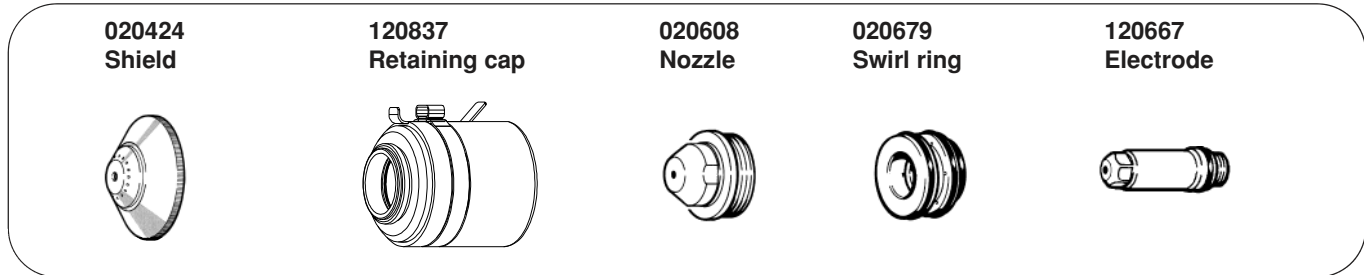

### Above Water

Material Thickness (inches)	Material Thickness (mm)	Plasma Gas Flow Rate %		Shield Gas (Air) Pressure (psi)	Torch-to-work Distance		Initial Torch Piercing Height		Arc Voltage Setting (volts)	Travel Speed		Approx. Motion Delay Time (sec)
		Preflow (Air %)	Cutflow (Air %)		(inches)	(mm)	(inches)	(mm)		(ipm)	(mm/min.)	
3/16	5	<b>54</b>	<b>65</b>	<b>60</b>	1/8	3	1/4	6	130	220	5600	0.5
1/4	6	(62.3	(75.0	(270	1/8	3	1/4	6	140	190	4800	1.0
3/8	10	SCFH)	SCFH)	SCFH)	1/8	3	1/4	6	140	145	3700	2.0
1/2	12				1/8	3	1/4	6	145	110	2800	2.5
5/8	15				.157	4	.314	8	150	85	2200	2.5
3/4	20				3/16	5	3/8	10	155	65	1650	2.5
7/8	22				1/4	6	1/2	12	160	50	1300	2.5
1	25				1/4	6			165	35	900	
1-1/4	32				1/4	6			170	20	500	
1-1/2	38				1/4	6			175	12	300	

### 3" Under Water

Material Thickness (inches)	Material Thickness (mm)	Plasma Gas Flow Rate %		Shield Gas (Air) Pressure (psi)	Torch-to-work Distance		Initial Torch Piercing Height		Arc Voltage Setting (volts)	Travel Speed		Approx. Motion Delay Time (sec)
		Preflow (Air %)	Cutflow (Air %)		(inches)	(mm)	(inches)	(mm)		(ipm)	(mm/min.)	
3/16	5	<b>54</b>	<b>65</b>	<b>70</b>	1/8	3	1/4	6	135	210	5300	0.5
1/4	6	(62.3	(75.0	(280	1/8	3	1/4	6	140	170	4300	1.0
3/8	10	SCFH)	SCFH)	SCFH)	1/8	3	1/4	6	145	125	3150	2.0
1/2	12				1/8	3	1/4	6	150	90	2240	2.5
5/8	15				.157	4	.314	8	155	65	1650	3.0
3/4	20				3/16	5	3/8	10	160	45	1150	3.0

Notes: **Set plasma gas inlet pressure to 90 psi (6.2 bar)**  
**Set shield gas inlet pressure to 90 psi (6.2 bar)**  
 Production cutting above 7/8" (22 mm) not recommended

## Aluminum

200 amps • N<sub>2</sub> Plasma / Air Shield

This gas combination is used when cut edge quality is less important. Electrode life is extended when this combination is used.

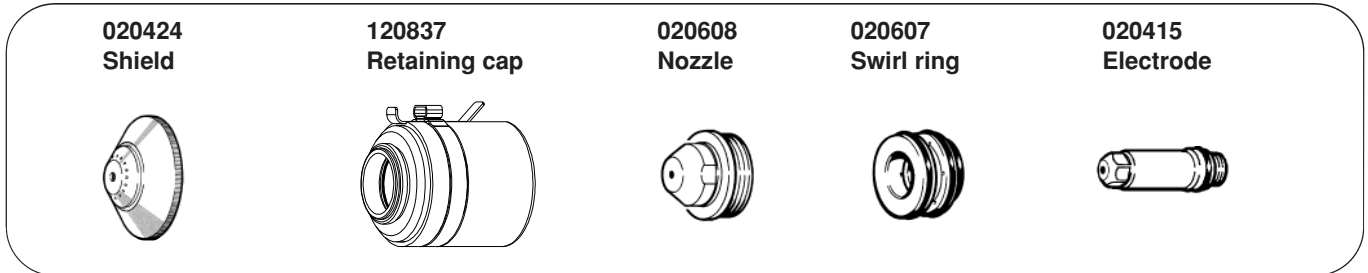

### Above Water

Material Thickness (inches) (mm)		Plasma Gas Flow Rate %		Shield Gas (Air) Pressure (psi)	Torch-to-work Distance (inches) (mm)		Initial Torch Piercing Height (inches) (mm)		Arc Voltage Setting (volts)	Travel Speed (ipm) (mm/min.)		Approx. Motion Delay Time (sec)
		Preflow (N <sub>2</sub> %)	Cutflow (N <sub>2</sub> %)		(inches)	(mm)	(inches)	(mm)		(ipm)	(mm/min.)	
3/16	5	<b>50</b>	<b>60</b>	<b>60</b>	1/8	3	1/4	6	130	180	4570	0.5
1/4	6	(66.4)	(79.6)	(270)	1/8	3	1/4	6	135	160	4060	1.0
3/8	10	SCFH)	SCFH)	SCFH)	1/8	3	1/4	6	135	120	3050	1.5
1/2	12				1/8	3	1/4	6	140	80	2030	2.0
5/8	15				.157	4	.314	8	140	70	1780	2.0
3/4	20				3/16	5	3/8	10	150	50	1270	2.5
7/8	22				1/4	6	1/2	12	160	35	890	2.5
1	25				1/4	6			165	25	635	
1-1/4	32				1/4	6			175	20	510	
1-1/2	38				1/4	6			185	10	250	

### 3" Under Water

Material Thickness (inches) (mm)		Plasma Gas Flow Rate %		Shield Gas (Air) Pressure (psi)	Torch-to-work Distance (inches) (mm)		Initial Torch Piercing Height (inches) (mm)		Arc Voltage Setting (volts)	Travel Speed (ipm) (mm/min.)		Approx. Motion Delay Time (sec)
		Preflow (N <sub>2</sub> %)	Cutflow (N <sub>2</sub> %)		(inches)	(mm)	(inches)	(mm)		(ipm)	(mm/min.)	
3/16	5	<b>50</b>	<b>60</b>	<b>70</b>	1/8	3	1/4	6	135	170	4350	0.5
1/4	6	(66.4)	(79.6)	(280)	1/8	3	1/4	6	140	140	3650	1.0
3/8	10	SCFH)	SCFH)	SCFH)	1/8	3	1/4	6	140	100	2600	1.5
1/2	12				1/8	3	1/4	6	145	65	1620	2.0
5/8	15				.157	4	.314	8	145	55	1350	2.5
3/4	20				3/16	5	3/8	10	155	35	890	3.0
7/8	22				1/4	6	1/2	12	165	25	620	3.0

Notes: **Set plasma gas inlet pressure to 120 psi (8.3 bar)**  
**Set shield gas inlet pressure to 90 psi (6.2 bar)**  
 Production cutting above 7/8" (22 mm) not recommended



## OPERATION

### Aluminum

200 amps • N<sub>2</sub> Plasma / CO<sub>2</sub> Shield

This gas combination is used when cut edge quality is less important. Electrode life is extended when this combination is used.

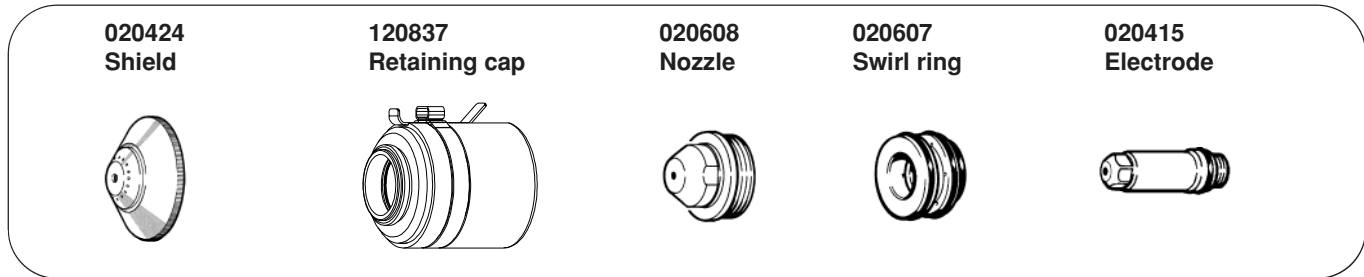

### Above Water

Material Thickness (inches)	Material Thickness (mm)	Plasma Gas Flow Rate %		Shield Gas (CO <sub>2</sub> ) Pressure (psi)	Torch-to-work Distance		Initial Torch Piercing Height		Arc Voltage Setting (volts)	Travel Speed		Approx. Motion Delay Time (sec)
		Preflow (N <sub>2</sub> %)	Cutflow (N <sub>2</sub> %)		(inches)	(mm)	(inches)	(mm)		(ipm)	(mm/min.)	
3/16	5	<b>50</b>	<b>60</b>	<b>60</b>	1/8	3	1/4	6	130	185	4700	0.5
1/4	6	(66.4	(79.6	(210	1/8	3	1/4	6	135	160	4050	1.0
3/8	10	SCFH)	SCFH)	SCFH)	1/8	3	1/4	6	135	120	3050	2.0
1/2	12				1/8	3	1/4	6	140	95	2400	2.5
5/8	15				.157	4	.314	8	140	70	1800	2.5
3/4	20				3/16	5	3/8	10	150	55	1400	3.0
7/8	22				1/4	6	1/2	12	160	42	1050	3.0
1	25				1/4	6			165	33	840	
1-1/4	32				1/4	6			175	20	510	
1-1/2	38				5/16	8			185	11	280	

### 3" Under Water

Material Thickness (inches)	Material Thickness (mm)	Plasma Gas Flow Rate %		Shield Gas (CO <sub>2</sub> ) Pressure (psi)	Torch-to-work Distance		Initial Torch Piercing Height		Arc Voltage Setting (volts)	Travel Speed		Approx. Motion Delay Time (sec)
		Preflow (N <sub>2</sub> %)	Cutflow (N <sub>2</sub> %)		(inches)	(mm)	(inches)	(mm)		(ipm)	(mm/min.)	
3/16	5	<b>50</b>	<b>60</b>	<b>60</b>	1/8	3	1/4	6	130	175	4450	0.5
1/4	6	(66.4	(79.6	(220	1/8	3	1/4	6	135	145	3650	1.0
3/8	10	SCFH)	SCFH)	SCFH)	1/8	3	1/4	6	140	100	2600	2.0
1/2	12				1/8	3	1/4	6	145	75	1820	2.5
5/8	15				.157	4	.314	8	145	55	1350	2.5
3/4	20				3/16	5	3/8	10	155	40	980	3.0
7/8	22				1/4	6	1/2	12	165	30	750	3.0

Notes: **Set plasma gas inlet pressure to 120 psi (8.3 bar)**  
**Set shield gas inlet pressure to 90 psi (6.2 bar)**  
 Production cutting above 7/8" (22 mm) not recommended

## Aluminum

200 amps • H35 Plasma / N<sub>2</sub> Shield

Argon-Hydrogen Manifold (073109) Required\*

This gas combination (Hypertherm recommends a mixture of 35% hydrogen and 65% argon for the plasma gas) gives maximum thickness cutting capability, excellent cut quality and excellent weldability. Electrode life is extended when this combination is used.

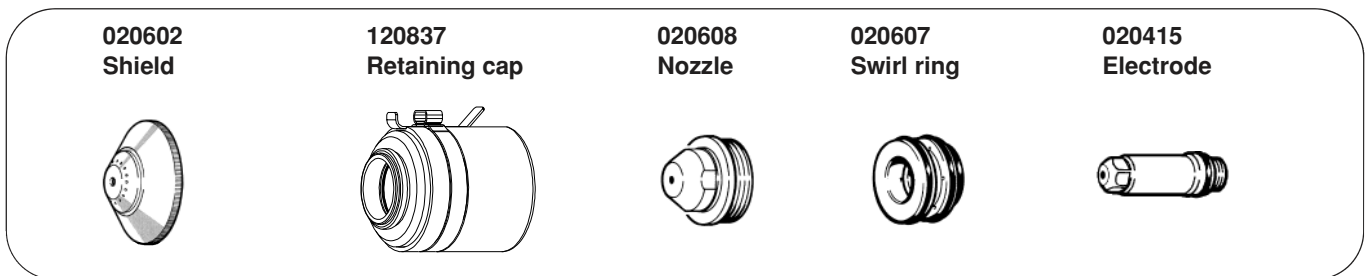
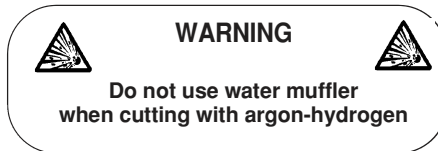

### Above Water Only

Material Thickness (inches) (mm)	Plasma Gas Flow Rate %		Shield Gas (N <sub>2</sub> ) Pressure (psi)	Torch-to-work Distance (inches) (mm)		Initial Torch Piercing Height (inches) (mm)		Arc Voltage Setting (volts)	Travel Speed (ipm) (mm/min.)		Approx. Motion Delay Time (sec)	
	Preflow (H35 %)	Cutflow (H35 %)										
3/16	5	<b>25</b>	<b>60</b>	3/16	5	3/8	10	130	170	4300	0.5	
1/4	6	(89.9)	(275)	3/16	5	3/8	10	130	155	4000	1.0	
3/8	10	SCFH)	SCFH)	SCFH)	1/4	6	1/2	12	135	120	3000	2.0
1/2	12				1/4	6	1/2	12	140	100	2550	2.0
5/8	15				1/4	6	1/2	12	145	80	2000	2.5
3/4	20				5/16	8	5/8	16	150	60	1500	2.5
7/8	22				5/16	8	5/8	16	155	50	1250	2.5
1	25				5/16	8			155	40	1000	
1-1/4	32				5/16	8			165	26	660	
1-1/2	38				5/16	8			170	18	460	
1-3/4	44				5/16	8			180	12	300	
2	50				5/16	8			185	7	180	

\* See Section 7 for installation and operation with Argon-Hydrogen Manifold.

Notes: **Set plasma gas inlet pressure to 120 psi (8.3 bar)**  
**Set shield gas inlet pressure to 90 psi (6.2 bar)**  
 Production cutting above 7/8" (22 mm) not recommended

## OPERATION

### Aluminum

100 amps • Air Plasma / Air Shield

This gas combination gives good cut speed, low dross levels and is very economical.

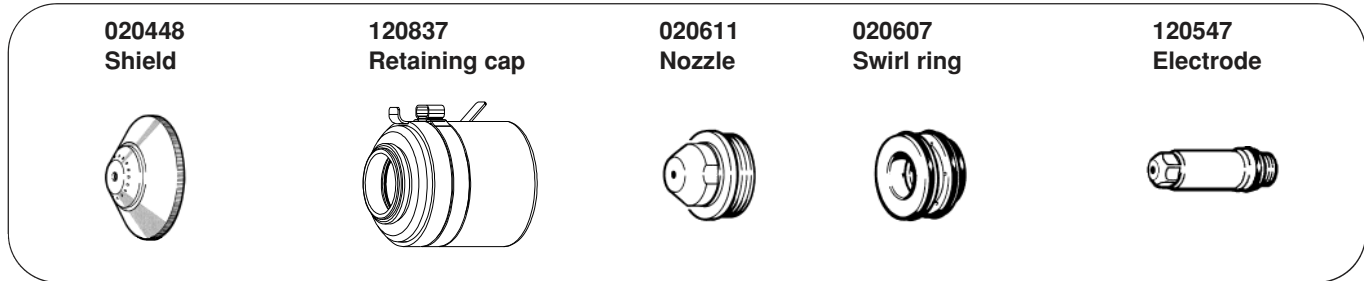

### Above Water

Material Thickness (inches) (mm)		Plasma Gas Flow Rate %		Shield Gas (Air) Pressure (psi)	Torch-to-work Distance		Initial Torch Piercing Height		Arc Voltage Setting (volts)	Travel Speed		Approx. Motion Delay Time (sec)
		Preflow (Air %)	Cutflow (Air %)		(inches)	(mm)	(inches)	(mm)		(ipm)	(mm/min.)	
1/8	3	<b>48</b>	<b>39</b>	<b>60</b>	3/32	2.5	3/16	5	135	110	2800	
3/16	5	(55.3)	(44.9)	(270)	1/8	3	1/4	6	140	90	2290	0.5
1/4	6	SCFH)	SCFH)	SCFH)	1/8	3	1/4	6	145	70	1780	0.5
3/8	10				1/8	3	1/4	6	145	50	1270	0.5
1/2	12				1/8	3			150	40	1010	
5/8	15				.157	4			155	30	760	
3/4	20				3/16	5			160	25	635	

### 3" Under Water

Material Thickness (inches) (mm)		Plasma Gas Flow Rate %		Shield Gas (Air) Pressure (psi)	Torch-to-work Distance		Initial Torch Piercing Height		Arc Voltage Setting (volts)	Travel Speed		Approx. Motion Delay Time (sec)
		Preflow (Air %)	Cutflow (Air %)		(inches)	(mm)	(inches)	(mm)		(ipm)	(mm/min.)	
1/8	3	<b>48</b>	<b>39</b>	<b>70</b>	5/64	2	5/32	4	135	100	2650	
3/16	5	(55.3)	(44.9)	(280)	1/8	3	1/4	6	140	80	2050	0.5
1/4	6	SCFH)	SCFH)	SCFH)	1/8	3	1/4	6	145	60	1510	0.5
3/8	10				1/8	3	1/4	6	150	40	1000	0.5
1/2	12				1/8	3			155	30	750	

Notes: **Set plasma gas inlet pressure to 90 psi (6.2 bar)**  
**Set shield gas inlet pressure to 90 psi (6.2 bar)**  
 Production cutting above 3/8" (10 mm) not recommended

## Aluminum

100 amps • H35 Plasma / N<sub>2</sub> Shield  
Argon-Hydrogen Manifold (073109) Required\*

This gas combination (Hypertherm recommends a mixture of 35% hydrogen and 65% argon for the plasma gas) gives good cut speed, low dross levels and is very economical.

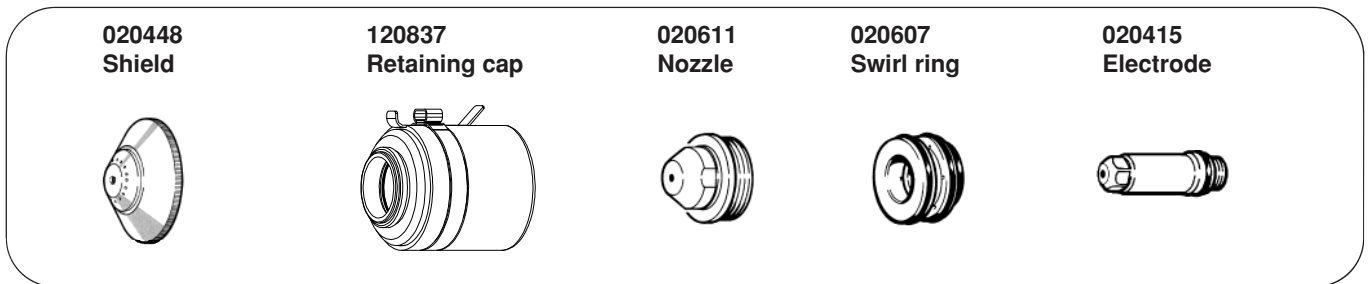
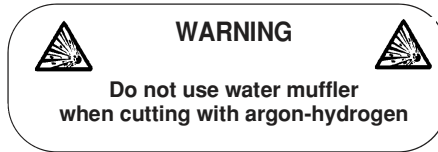

### Above Water Only

Material Thickness (inches) (mm)	Plasma Gas Flow Rate %		Shield Gas (N <sub>2</sub> ) Pressure (psi)	Torch-to-work Distance (inches) (mm)		Initial Torch Piercing Height (inches) (mm)		Arc Voltage Setting (volts)	Travel Speed (ipm) (mm/min.)		Approx. Motion Delay Time (sec)
	Preflow (H35 %)	Cutflow (H35 %)									
1/8 3	<b>13</b>	<b>13</b>	<b>60</b>	3/32 2.5	3/16 5	135	95 2440				
3/16 5	(46.7)	(46.7)	(270)	1/8 3	1/4 6	140	85 2200	0.5			
1/4 6	SCFH)	SCFH)	SCFH)	1/8 3	1/4 6	145	80 1980	0.5			
3/8 10				1/8 3	1/4 6	145	60 1530	0.5			
1/2 12				1/8 3		150	50 1280				

\* See Section 7 for installation and operation with Argon-Hydrogen Manifold.

Notes: **Set plasma gas inlet pressure to 120 psi (8.3 bar)**  
**Set shield gas inlet pressure to 90 psi (6.2 bar)**  
Production cutting above 3/8" (10 mm) not recommended

## OPERATION

### Aluminum

40 amps • Air Plasma / Air Shield

This gas combination gives good cut speed, low dross levels and is very economical.

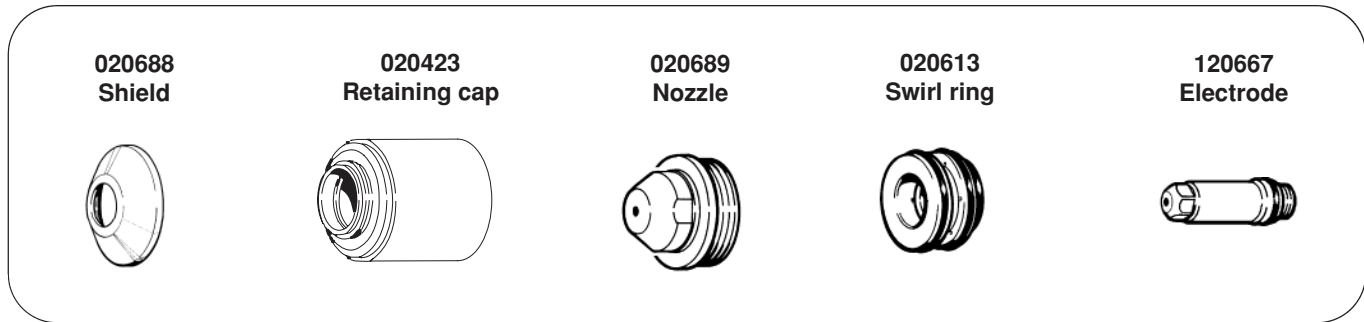

### Above Water Only

Material Thickness (inches) (mm)	Plasma Gas Flow Rate %		Shield Gas (Air) Pressure (psi)	Torch-to-work Distance (inches) (mm)		Initial Torch Piercing Height (inches) (mm)		Arc Voltage Setting (volts)	Travel Speed (ipm) (mm/min.)		Approx. Motion Delay Time (sec)
	Preflow (Air %)	Cutflow (Air %)									
3/32	2.5	<b>40</b>	<b>60</b>	3/32	2.5	3/16	5	120	140	3550	0.5
1/8	3	(46.0)	(275)	3/32	2.5	3/16	5	130	100	2550	
1/4	6	SCFH)	SCFH)	1/8	3			140	35	900	
3/8	10			1/8	3			150	15	350	

Notes: **Set plasma gas inlet pressure to 90 psi (6.2 bar)**  
**Set shield gas inlet pressure to 90 psi (6.2 bar)**  
 Production cutting above 1/8" (3 mm) not recommended